

A THEORETICAL VIEW OF DISTRIBUTED SYSTEMS

Nancy Lynch, MIT EECS, CSAIL
Sorbonne, September 12, 2019

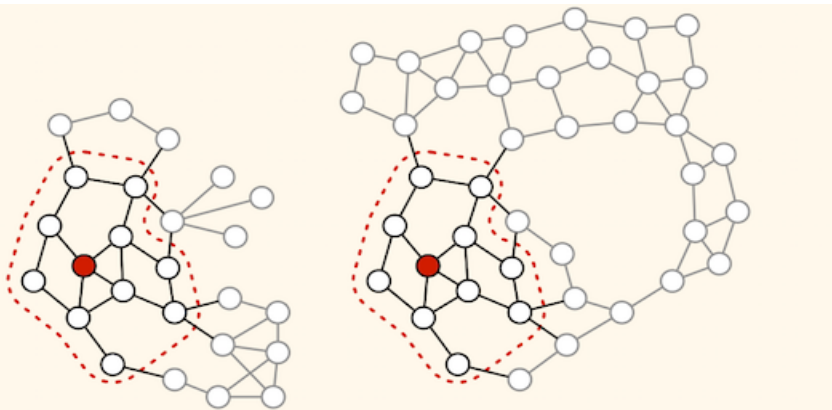

Theory for Distributed Systems

- We have worked on theory for distributed systems, trying to understand (mathematically) their capabilities and limitations.
- This work has included:
 - Defining abstract, mathematical **models** for **problems** solved by distributed systems, and for the **algorithms** used to solve them.
 - Developing some new **algorithms**.
 - Producing **proofs** of correctness, performance, fault-tolerance.
 - Proving **impossibility results** and lower bounds, expressing inherent limitations of distributed systems for solving problems.
 - Developing **foundations** for modeling, analyzing distributed systems.
- Kinds of systems:
 - Distributed data-management systems.
 - Wired, wireless communication systems.
 - Biological systems: Insect colonies, developmental biology, brains.

This talk:

1. Algorithms for Traditional Distributed Systems
2. Impossibility Results
3. Foundations
4. Algorithms for New Distributed Systems

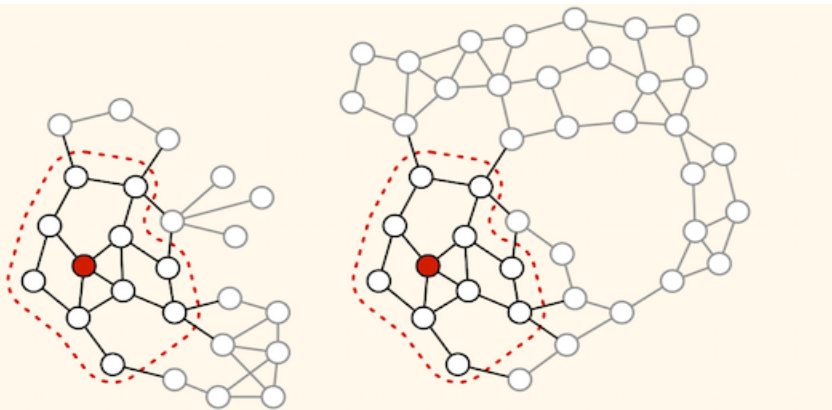

1. Algorithms for Traditional Distributed Systems

- Mutual exclusion in shared-memory systems, resource allocation: Fischer, Burns,...late 70s and early 80s.
- Dolev, Lynch, Pinter, Stark, Weihl. Reaching approximate agreement in the presence of faults. JACM,1986.
- Lundelius, Lynch. A new fault-tolerant algorithm for clock synchronization. Information and Computation,1988.
- Dwork, Lynch, Stockmeyer. Consensus in the presence of partial synchrony. JACM,1988. Dijkstra Prize, 2007.

Dwork, Lynch, Stockmeyer [DLS]

“This paper introduces a number of practically motivated partial synchrony models that lie between the completely synchronous and the completely asynchronous models and in which consensus is solvable.

It gave practitioners the right tool for building fault-tolerant systems and contributed to the understanding that **safety can be maintained at all times, despite the impossibility of consensus, and progress is facilitated during periods of stability.**

These are the pillars on which every fault-tolerant system has been built for two decades. This includes academic projects, as well as real-life data centers, such as the Google file system.”

Distributed consensus

- Processors in a distributed network want to agree on a value in some set V .
- Each processor starts with an initial value in V , and they want to agree on a value in V .
- But some of the processors might be faulty (stopping, or Byzantine).
- **Agreement:** All nonfaulty processors agree.
- **Validity:** If all processors have the same initial value v , then v is the only allowed decision for a nonfaulty processor.
- Problem arose as:
 - The Database Commit problem [Gray 78].
 - The Byzantine Agreement problem (for altitude sensor readings) [Pease, Shostak, Lamport 80].

[DLS] contributions

- Considers a **variety of partial synchrony models**, with different processor rate and message-delay assumptions.
- Considers a **variety of failure models**: stopping failures, Byzantine failures, Byzantine failure with authentication, sending and receiving omission failures,...
- Gives algorithms to reach agreement in all cases, guaranteeing agreement and validity always, and termination when the system's behavior stabilizes.
- Key algorithmic ideas:
 - Different processors try to take charge of reaching agreement.
 - Rotating coordinator.
 - Must reconcile to avoid contradictory decisions.

[DLS] contributions

- E.g., consider **stopping failures, synchronous rounds**.
- Messages may be lost, but after some **Global Stabilization Time**, all messages between nonfaulty processors are delivered.
- 4-round phases, coordinator p_i , $i = k \bmod n$, at phase k .
- A processor may **lock a value v with phase number k** , meaning that it thinks that the coordinator might decide v at phase k .
- **Phase k** , coordinator p_i , $i = k \bmod n$
 - **Round 1:** Each processor p_j sends “acceptable” decision values (known to be someone’s initial value, p_j doesn’t hold a lock on a different value) to p_i ; p_i tries to find a value v to propose, acceptable to a majority of processors.
 - **Round 2:** p_i broadcasts proposed value v , recipients lock (v, k) .
 - **Round 3:** Those who locked (v, k) send acks to p_i ; if p_i receives a majority of acks, decides v .
 - **Round 4:** Cleanup, exchange lock info, release older locks.

[DLS] contributions

- Phase k , coordinator $p_i, i = k \bmod n$
 - Round 1: Send acceptable decision values to p_i ; p_i tries to pick a value v to propose, one that is acceptable to a majority of processors.
 - Round 2: p_i broadcasts proposed value v , recipients lock (v, k) .
 - Round 3: Those who locked (v, k) send acks to p_i ; if p_i receives majority of acks, decides v .
 - Round 4: Cleanup, exchange lock info, release older locks.
- Some ideas inspired by [\[Skeen 3-phase commit\]](#).
- [\[Paxos\]](#) consensus protocol uses similar ideas.

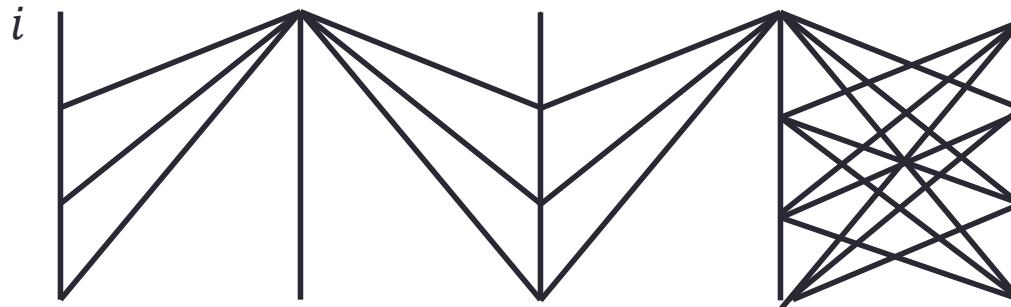

Other Work on Algorithms for Traditional Distributed Systems

- Concurrency control for nested transactions
- Distributed shared memory
- Group communication
- RAMBO, dynamic atomic memory

Concurrency Control Algorithms for Nested Transactions

- Lynch, Merritt, Weihl, Fekete. Atomic Transactions in Concurrent/Distributed Systems. Morgan Kaufmann, 1993.
- Background:
 - Transactions, concurrency control: [Gray], [Bernstein, Goodman].
 - Extensions to nested transactions: [Liskov]
 - Systems papers, implementations, little theory.
- Our contributions:
 - Modeled nested transactions rigorously.
 - Described existing algorithms precisely, generalized them.
 - Proved correctness.
- Many papers, book.

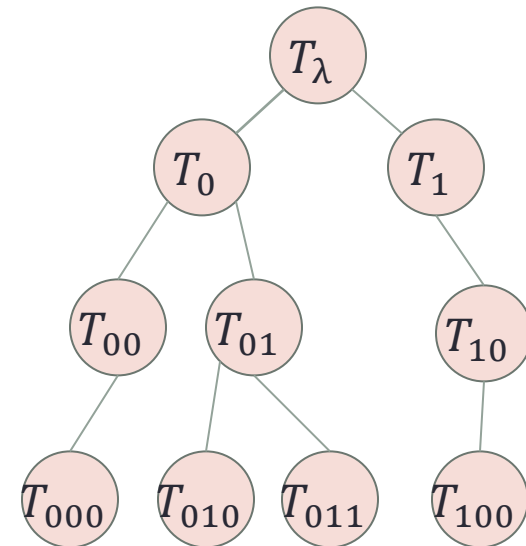

Concurrency Control Algorithms for Nested Transactions

- General theory for nested transactions, including a general **Atomicity Theorem** that provides a compositional method for proving correctness of concurrency control algorithms
- Lock-based algorithms.
- Timestamp-based algorithms.
- Hybrid locking/timestamp algorithms.
- Optimistic concurrency control algorithms.
- Orphan management algorithms.
- Replicated data mgmt. algorithms.
- All rigorously, in terms of the **I/O automata modeling framework.**

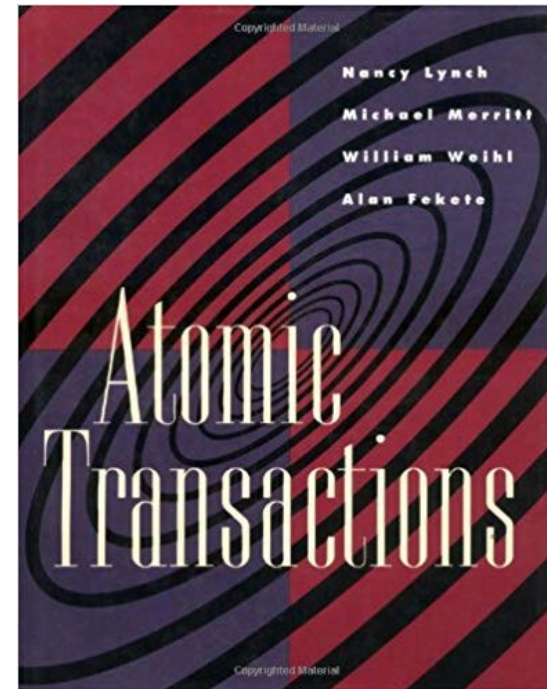

Distributed Shared Memory

- Fekete, Kaashoek, Lynch. Implementing sequentially consistent shared objects using broadcast and point-to-point communication. ICDCS, 1995. JACM, 1998.

[Fekete, Kaashoek, Lynch, 1988]

- Considered an algorithm to implement **sequentially consistent read/update shared memory**, using basic broadcast and point-to-point communication services as in Amoeba.
- Based on **Orca system** [Bal, Kaashoek, Tanenbaum 93], for writing applications for clusters of workstations.
- Orca defines an **abstract Multicast Channel**, with strong ordering and causality properties.
- **Implements the Multicast Channel over basic broadcast and point-to-point communication services**, using a sequence-number-based protocol.
- **Implements sequentially consistent memory over any Multicast Channel**, using a partial replication strategy (read any copy, update all copies).

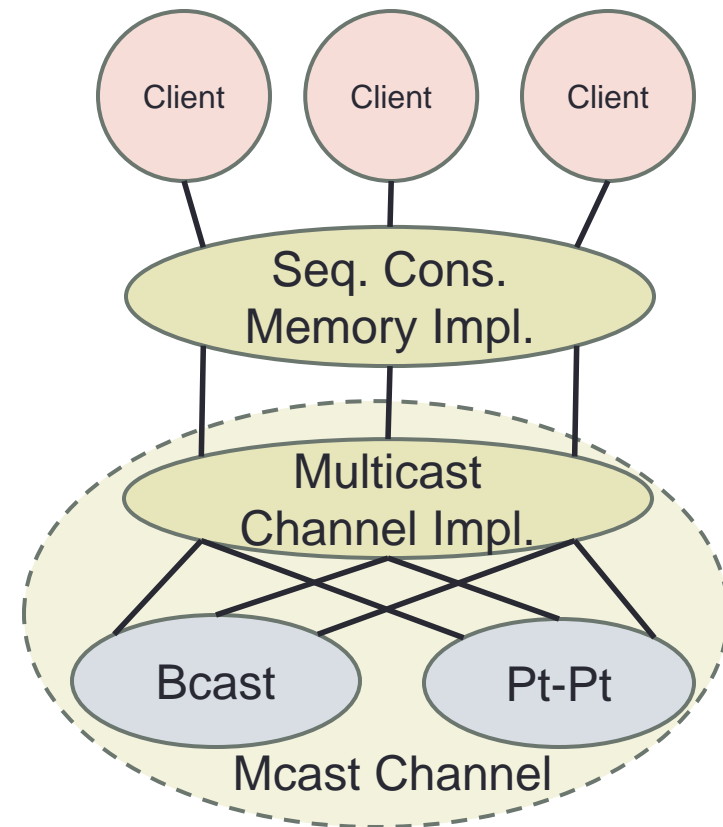

[FKL] contributions

- We specified the message delivery and ordering requirements of the **Multicast Channel** formally.
- Defined a **sequence-number-based algorithm** to implement the Mcast Channel over the basic communication services.
- We tried to prove the algorithm correct.
- But, we discovered an **algorithmic error** in the Orca implementation:
 - Didn't piggyback needed sequence numbers on certain response messages.
- Error was fixed in the system.
- We completed the proof.

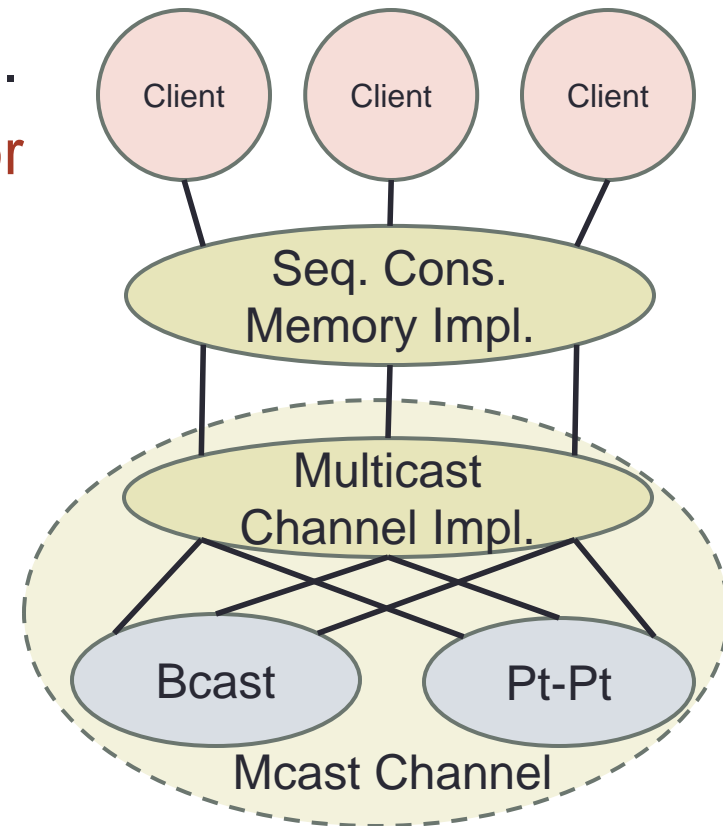

[FKL] contributions

- Defined a **sequence-number-based algorithm** to implement the Multicast Channel over the basic communication services, proved it correct.
- We defined a **partial-replication algorithm** to implement sequentially consistent memory over the Mcast Channel, generalizing the Orca algorithm.
- Developed a **new proof technique** for proving sequential consistency.
- Using I/O automata, composition, abstraction.

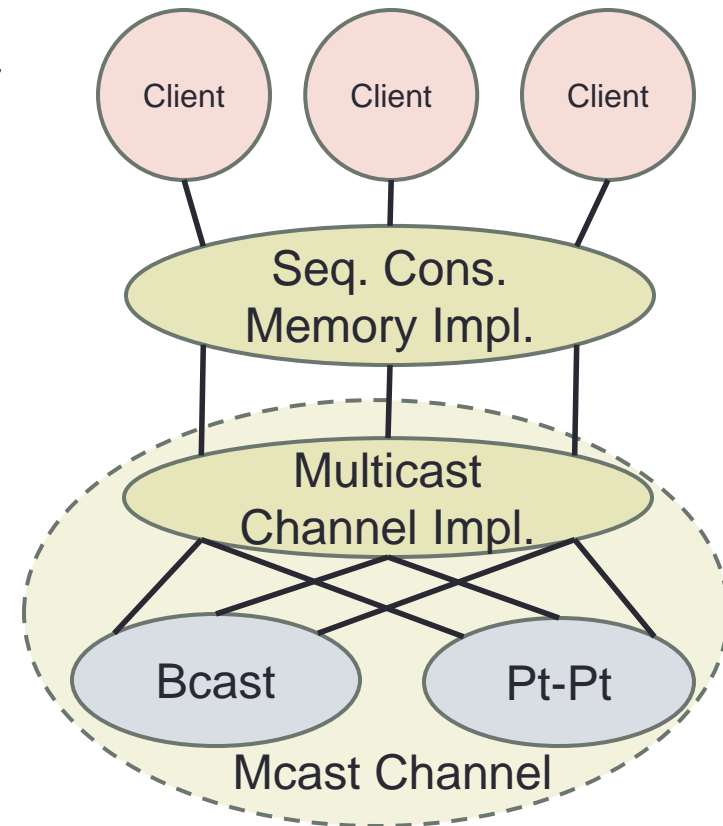

Group Communication Services

- Hickey, Lynch, van Renesse.
Specifications and proofs for Ensemble
layers. TACAS, 1999.

[Hickey, Lynch, van Renesse, 1999]

- We studied the **Ensemble Group Communication (GC) system** of Hayden, van Renesse, Birman, et al.
- Ensemble supports distributed programming by providing guarantees for synchronization, message ordering, message delivery.
- Tolerates failures and recoveries.
- Organizes processors into **views**, with consistency guarantees for message deliveries within views.
- Combinations of guarantees packaged into (~50) different **layers**.

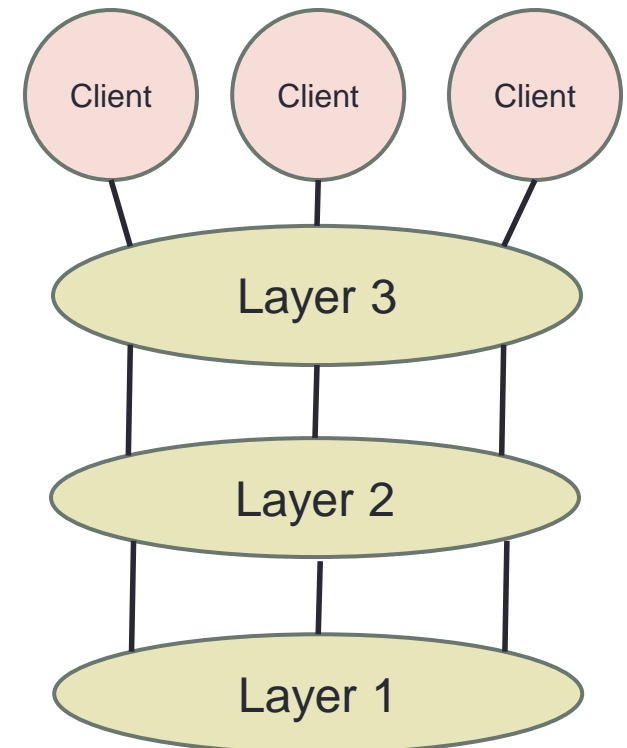

[HLvR] contributions

- We studied two key Ensemble layers, and the relationship between them, formally, using I/O automata:
 - Ensemble Virtual Synchrony (EVS),
 - Ensemble Total Order (ETO),
 - EVStoETO, distributed algorithm that uses VS to implement TO.
- Ensemble Virtual Synchrony:
 - Basic GC semantics, processors join and leave **views**.
 - Messages sent in a view are delivered in the same view, FIFO for each (sender, receiver), same messages to all receivers.
- Ensemble Total Order:
 - Adds consistent global total order and causal order guarantees.

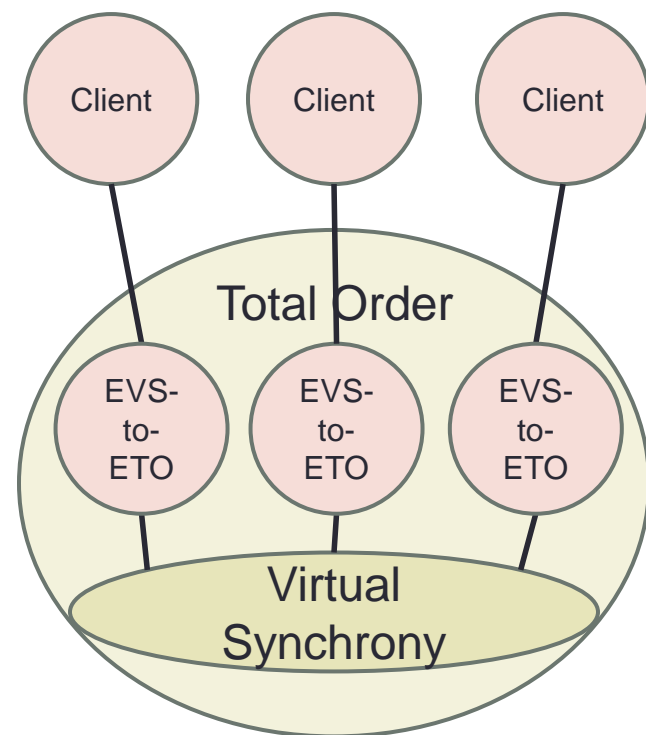

[HLvR] contributions

- EVS:
 - GC, views.
 - Messages sent and delivered in same view, FIFO for each (sender, receiver), same messages to all receivers.
- ETO:
 - Adds total order, causal order guarantees.
- EVStoETO:
 - 2-phase token-based algorithm.
- Proved that **VS + EVStoETO** implements ETO.
- Implementation is a **simulation relation**.

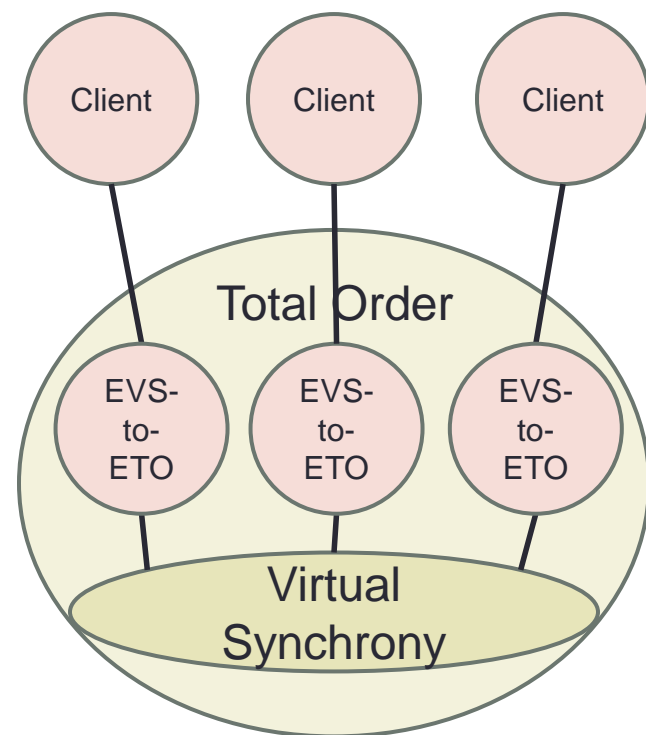

[HLvR] contributions

- Discovered an **algorithmic error** in the Ensemble implementation:
 - Some message deliveries in the implementation were not allowed by the ETO specification
 - Problem showed up in one step of the simulation proof.
- Error was fixed in the system.
- Completed the proof.
- Uses I/O automata, composition, abstraction.

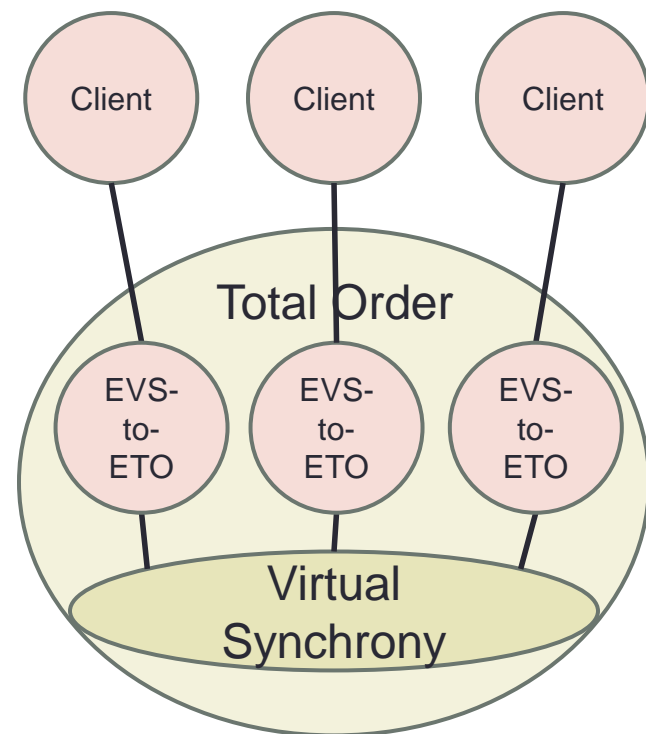

Summary: System modeling and proofs

- Using automata-based formal methods, we modeled, verified many distributed data-management systems, especially those with strong consistency requirements.
- Specified required properties formally.
- Defined abstract versions of systems algorithms.
- Clarified ambiguities.
- Proved the algorithms correct.
- Found and fixed algorithmic errors in implemented systems.

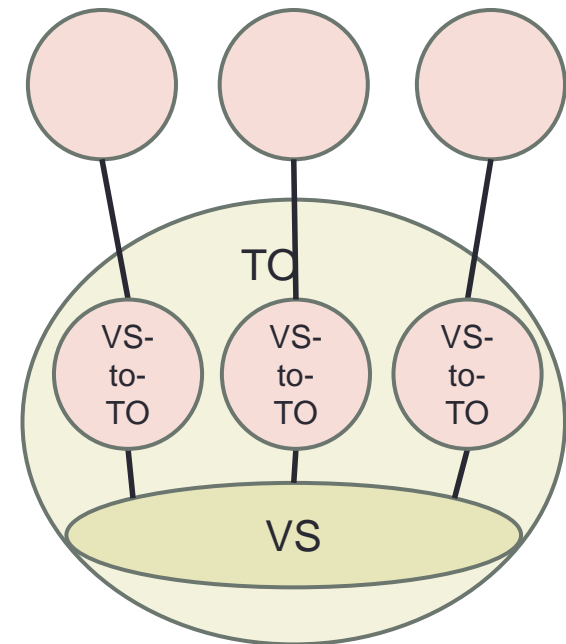
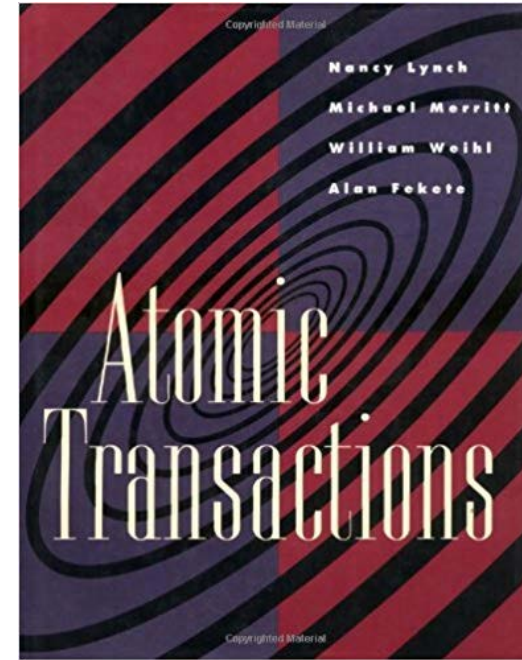

Reconfigurable Atomic Memory

- Lynch, Shvartsman. RAMBO: A reconfigurable atomic memory service for dynamic networks. DISC, 2002.
- Gilbert, Lynch, Shvartsman. RAMBO II: Rapidly Reconfigurable Atomic Memory for Dynamic Networks. DSN, 2003.
- Gilbert, Lynch, Shvartsman. RAMBO: A Robust, Reconfigurable Atomic Memory Service for Dynamic Networks. Distributed Computing, 2010.



Goal

- Implement **atomic Read/Write shared memory** in a **dynamic network setting**.
 - Atomic memory “looks like” centralized shared memory.
 - Participants may join, leave, fail during computation.
 - Mobile networks, peer-to-peer networks.
- High availability, low latency.
- Atomicity in spite of asynchrony and change.
- Good performance under limits on asynchrony and change.
- Applications:
 - Soldiers in a military operation.
 - First responders in a natural disaster.



Atomic Memory in Static Networks

[Attiya, Bar-Noy, Dolev 95]

- **Read-quorums, write-quorums** of processors; every read-quorum intersects every write-quorum.
- Replicate objects everywhere, with version tags.
- **To Read:** Contact a read-quorum, determine the latest version, propagate it to a write-quorum, return it.
- **To Write:** Contact a read-quorum, determine the latest tag, choose a larger tag, write (tag,value) to a write-quorum.
- Operations proceed concurrently, interleaving at fine granularity; still guarantees atomicity.

RAMBO algorithm

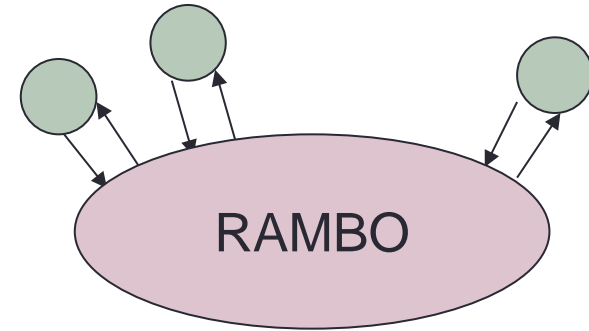

- **Reconfigurable Atomic Memory for Basic Objects** (i.e., reconfigurable atomic Read/Write shared memory).
- Uses **configurations**, each with:
 - **members**, a set of processors,
 - **read-quorums**, **write-quorums**
- Objects are replicated at all members of \mathcal{C} .
- Reads and Writes access quorums of \mathcal{C} , as in ABD; handles small, transient changes.
- To handle larger, more permanent changes, reconfigure to a new configuration \mathcal{C}' , moving object copies to members of \mathcal{C}' .

Algorithm structure

- Main algorithm + Reconfiguration service
- **Recon service:**
 - Supplies a consistent sequence of configurations.
 - Triggered by external reconfiguration requests.
- **Main algorithm:**
 - Handles reading and writing of objects.
 - Removes old configurations, in the background.
 - Reads/Writes use all currently-active configurations.
- All activities proceed concurrently, interleaving at fine granularity; still guarantees atomicity.

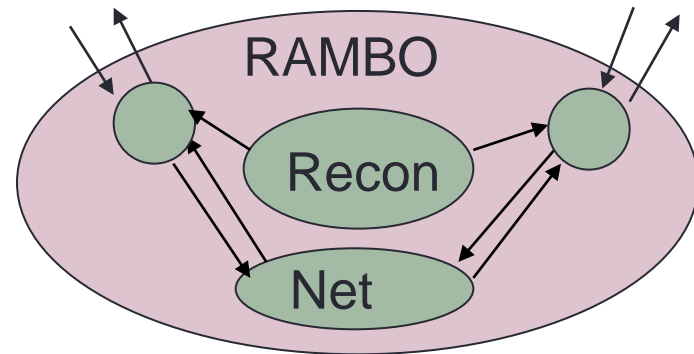

Reads and Writes

- Two-phase protocol:
- **Phase 1:** Collect object info (values, tags) from read-quorums of all known active configurations.
- **Phase 2:** Propagate latest object info to write-quorums of all known active configurations.

- Many Read/Write operations may execute concurrently.
- Quorum intersection properties guarantee atomicity.
- Each phase terminates by a fixed-point condition, involving a **quorum from each known active configuration.**

Removing old configurations

- “Garbage-collect” them in the background.
- Another two-phase protocol:
- **Phase 1:** For each old configuration C :
 - Inform a write-quorum of C about the new configuration.
 - Collect object information from a read-quorum of C .
- **Phase 2:**
 - Propagate latest object information to a write-quorum of the new configuration.
- GC proceeds concurrently with Reads and Writes, interleaving at fine granularity; still guarantees atomicity.

Implementing Recon

- Uses consensus to determine successive configurations.
- Members of old configuration can propose new configuration.
- Proposals reconciled using consensus.
- Consensus is a heavyweight mechanism, but:
 - Used only for reconfigurations, should be infrequent.
 - Does not delay Read/Write operations.

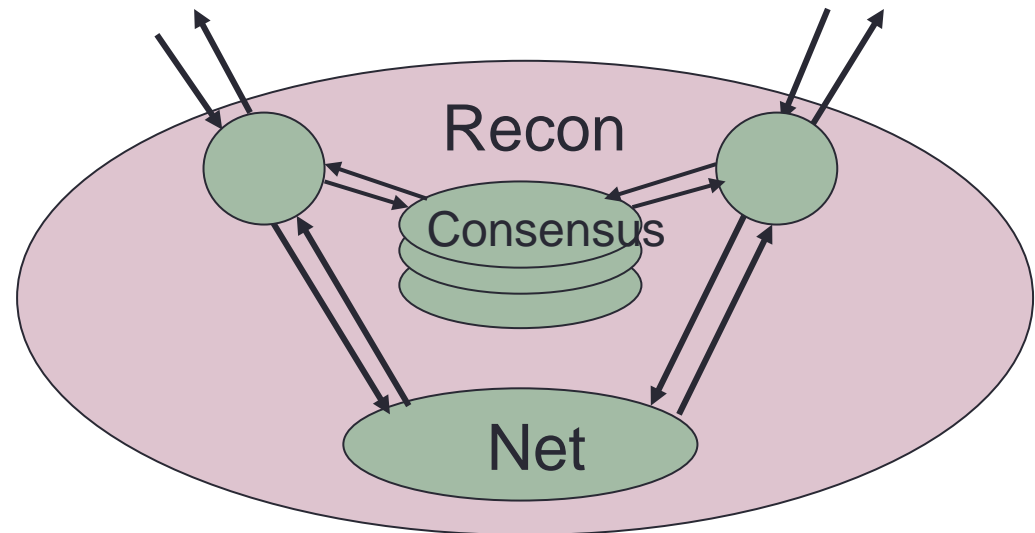

Implementing consensus

- Can use DLS, or Paxos.
- **Agreement, validity** always guaranteed.
- **Termination** guaranteed when underlying system stabilizes.

- All using Timed I/O Automata.
- Partial-order method for proving atomicity.

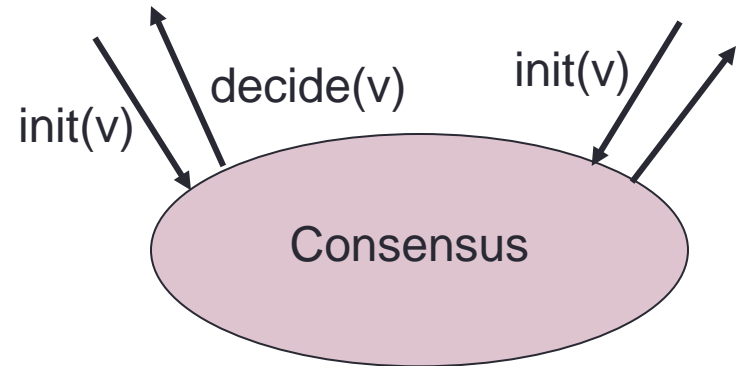

Compare with Paxos [Lamport 98]:

- In Paxos, consensus used for each successive operation, including Reads, Writes, and Recons.
- Completion of every operation depends on termination of consensus.
- In RAMBO, consensus used for Recons only.
- However, RAMBO supports only Reads and Writes, whereas Paxos can support more powerful read-modify-write operations.



This talk:

1. Algorithms for Traditional Distributed Systems
2. Impossibility Results
3. Foundations
4. Algorithms for New Distributed Systems

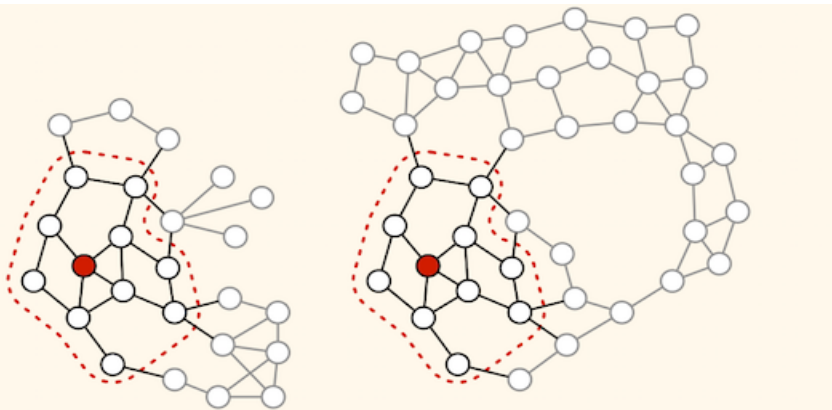

2. Impossibility Results

- Distributed algorithms have strong **inherent limitations**, because they must work in difficult settings:
 - Local knowledge only.
 - Uncertainties, about remote inputs, timing, failures.
- Theoretical models enable actual proofs of such limitations.
- **[Cremers, Hibbard 76]:**
 - Shared-memory, Boolean shared variables, arbitrary operations.
 - **Fair Mutual Exclusion:** Every process(or) that requests the resource eventually gets it.
 - Unsolvable for two processes with one Boolean shared variable.

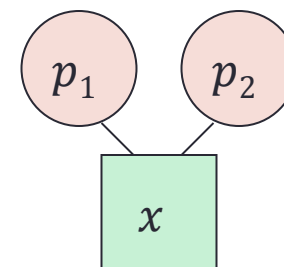

Impossibility Results: Mutual Exclusion

- Burns, Jackson, Lynch, Fischer, Peterson. Data requirements for implementation of n -process mutual exclusion using a single shared variable. JACM, 1982.

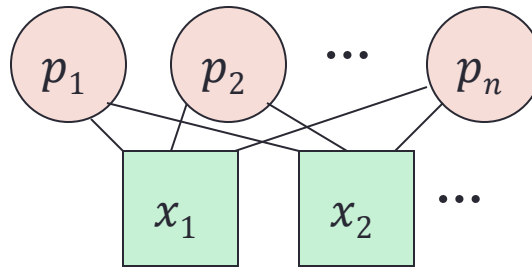

- Burns, Lynch. Bounds on shared memory for mutual exclusion. Information and Computation, 1993 (actually proved in ~1980).

[Burns, Lynch 93]

- **Theorem:** Mutual exclusion for n processes, using read/write shared memory, requires $\geq n$ shared variables.
- Even if:
 - Fairness is not required, just progress.
 - Everyone can read and write all variables.
 - Variables are of unbounded size.
- **Example:** $n = 2$
 - Suppose p_1 and p_2 solve mutual exclusion with progress, using one read/write shared variable x .
 - Suppose p_1 arrives, wants the resource. By the progress requirement, it must be able to get it.
 - Along the way, p_1 must write to x : If not, p_2 wouldn't know p_1 was there, so it could get the resource too, contradicting mutual exclusion.

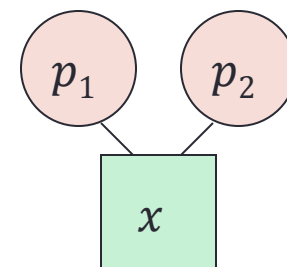

[Burns, Lynch] lower bound, $n = 2$

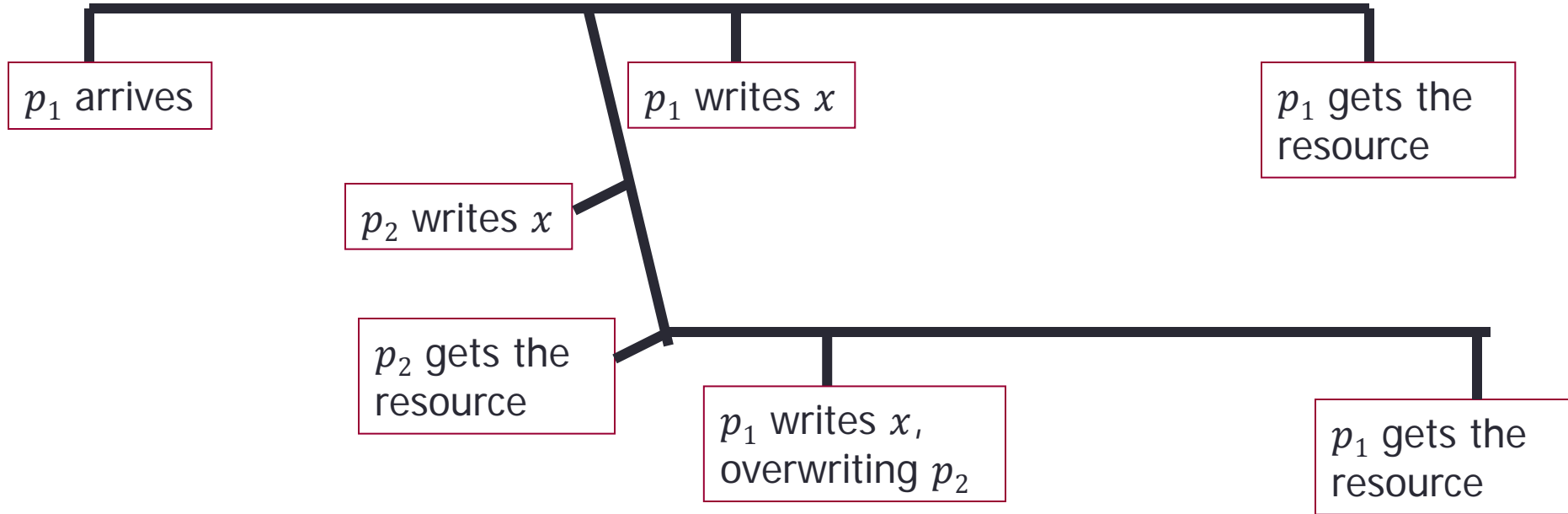

Contradicts mutual exclusion!

With $n > 2$ processes...

- Mutual exclusion with n processes, using read/write shared memory, requires n shared variables:

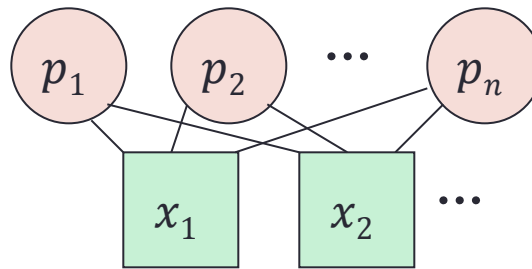

- Argument is more intricate, same key ideas:
 - Writing to a shared variable overwrites previous contents.
 - **Locality:** Process sees only its own state and the values it reads from shared variables.

Impossibility Results: Consensus

- Fischer, Lynch. A lower bound for the time to assure interactive consistency. IPL, 1982.
- Chaudhuri, Herlihy, Lynch, Tuttle. Tight bounds for k -set agreement. JACM, 2000.
- Fischer, Lynch, Paterson: Impossibility of distributed consensus with one faulty process. PODS, 1983; JACM, 1985.
- Fischer, Lynch, Merritt. Easy impossibility proofs for distributed consensus problems. Dist. Comp., 1986.

Distributed consensus

- Processes in a distributed network want to agree on a value in some set V .
- Each process starts with an initial value in V , and they want to agree on a value in V .
- Some processes might be faulty (stopping, or Byzantine).
- **Agreement:** All nonfaulty processes agree.
- **Validity:** If all processes have the same initial value v , then v is the only allowed decision for a nonfaulty process.

[Fischer, Lynch 82]

- Consensus in **synchronous systems**.
- All known algorithms had used $\geq f + 1$ rounds to reach consensus in the presence of up to f faulty processes.
- We showed that this is inherent: $f + 1$ rounds are needed in the worst case, even for stopping failures.
- **Proof idea:** Assume an f -round agreement algorithm tolerating f faults, get a contradiction.
- Assume:
 - n -node complete graph:
 - Binary decisions, $V = \{0,1\}$
 - Decisions right after round f .
 - All-to-all communication at every round.

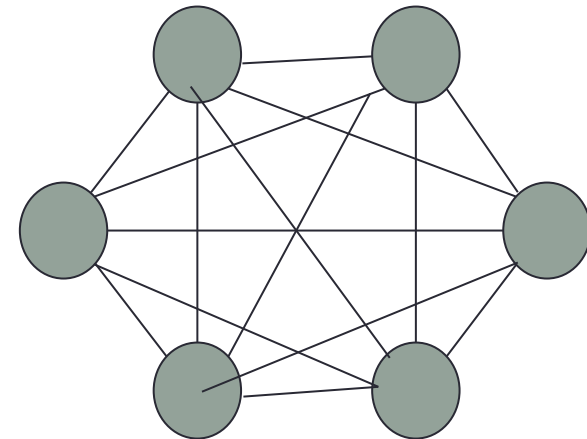

Special case: $f = 1$

- **Theorem 1:** There is no n -process 1-fault stopping agreement algorithm in which nonfaulty processes always decide at the end of round 1.
- **Proof:**
- By contradiction. Suppose there is such an algorithm.
- Construct a chain of executions, each with ≤ 1 failure, so that:
 - First execution must have (unique) decision value 0.
 - Last must have decision value 1.
 - Any two consecutive executions are indistinguishable to some process i that is nonfaulty in both. So i must decide the same in both executions, and the two executions must have the same decision values.
- So decision values in first and last executions must be the same, contradiction.

Lower bound proof, $f = 1$

- α_0 : All inputs 0, no failures.
- ...
- α_k : All inputs 1, no failures.
- Start chain from α_0 .
- Execution α_1 removes message 1 \rightarrow 2.
 - α_0 and α_1 indistinguishable to all except p_1 and p_2 , hence to some nonfaulty process.
- Execution α_2 , removes message 1 \rightarrow 3.
 - α_1 and α_2 indistinguishable to all except p_1 and p_3 , hence to some nonfaulty process.
- Remove message 1 \rightarrow 4.
 - Indistinguishable to some nonfaulty process.
- ...

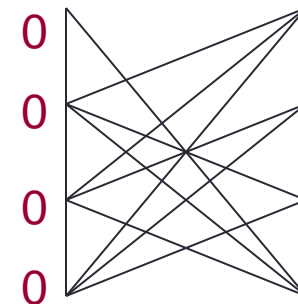
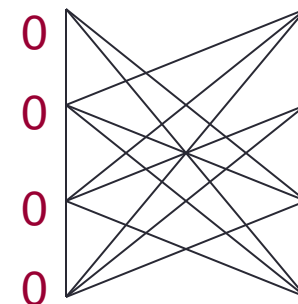
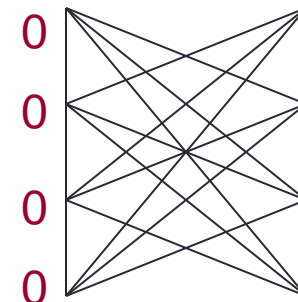

Continuing...

- Having removed all of p_1 's messages, change p_1 's input from 0 to 1.
 - Indistinguishable to everyone else.
- We can't just keep removing messages, since we are allowed ≤ 1 failure in each execution.
- So, we first replace missing messages (one at a time), until p_1 is no longer faulty.
- Repeat with p_2, p_3, \dots , eventually reach execution with all inputs 1, no failures.
- Yields the needed chain.

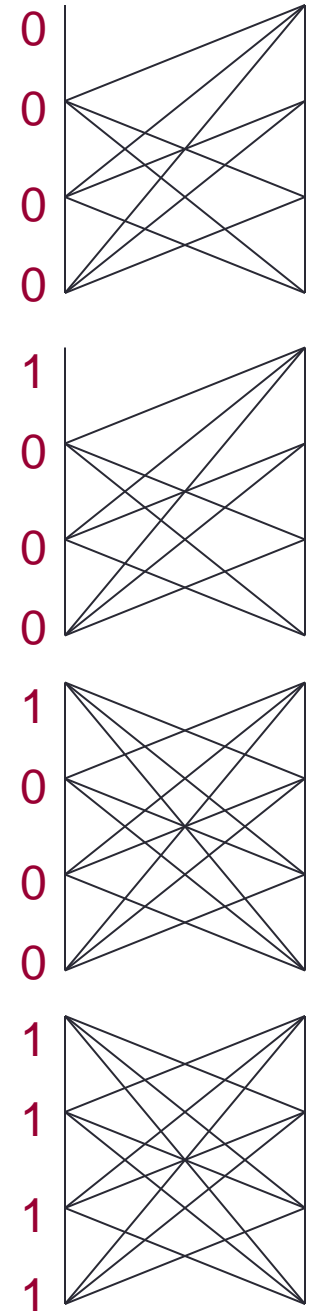

Lower bound proof, $f = 2$

- **Theorem 2:** There is no n -process 2-fault stopping agreement algorithm in which nonfaulty processes always decide at the end of round 2.
- **Proof:** Suppose there is.
- Construct a chain of executions, each with ≤ 2 failures.
- α_0 : All inputs 0, no failures.
- α_k : All inputs 1, no failures.
- Each consecutive pair indistinguishable to some nonfaulty process.
- E.g., consider how to change p_1 's initial value from 0 to 1.

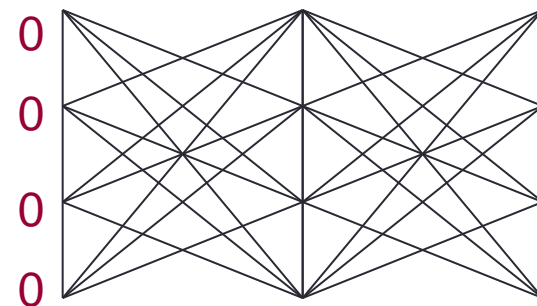

Lower bound proof, $f = 2$

- Start with α_0 , work toward killing p_1 at the start, to change its initial value, by removing its messages, one by one.
- Then work toward replacing the messages, one by one.
- Start by removing p_1 's round 2 messages, one by one.

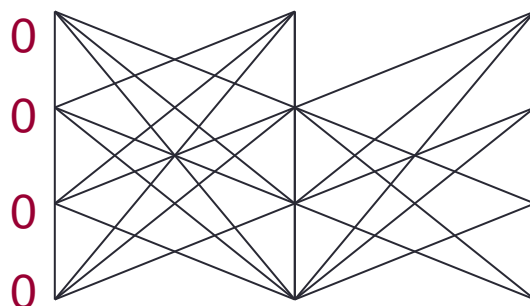

- Can't continue by removing p_1 's round 1 messages, since then consecutive executions would not look the same to anyone, e.g., removing $1 \rightarrow 2$ at round 1 allows p_2 to tell everyone about the failure, at round 2.

Lower bound proof, $f = 2$

- Removing $1 \rightarrow 2$ at round 1 lets p_2 tell everyone about the failure:

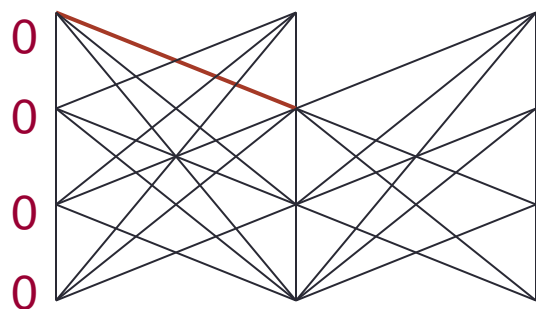

vs.

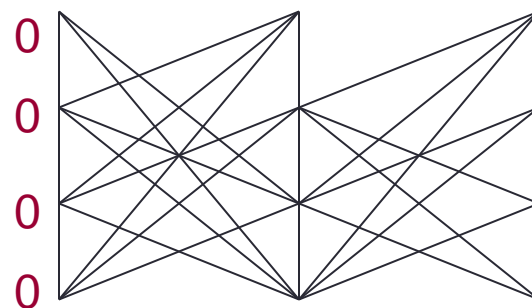

- So, use several steps to remove the round 1 message $1 \rightarrow 2$
- In these steps, both p_1 and p_2 are faulty.
- Remove all of p_2 's round 2 messages, one by one, replace them one by one.
- Repeat for all of p_1 's round 1 messages.
- Then change p_1 's initial value from 0 to 1, as needed.

[Fischer, Lynch, Paterson 83 (FLP)]

- Impossibility of consensus, in the presence of failures.
- **Theorem:** In an **asynchronous distributed system** in which at most one process may stop without warning, it is **impossible for the nonfaulty processes to reach agreement reliably**.
- Impossibility holds even for very limited failures:
 - At most one process ever fails.
 - Failed process simply stops.
- Result may seem counter-intuitive:
 - If there are many processes, and at most one can fail, then all but one should be able to agree, and later tell the remaining one.
 - This doesn't work!

[FLP] impossibility proof

- **By contradiction:** Assume a 1-fault-tolerant asynchronous algorithm that solves consensus, argue based on just the problem requirements that this cannot work.
- Assume $V = \{0,1\}$.
- **Execution:** A sequence of steps; in one step, one process receives one message, updates its state, and sends a finite number of messages.
- Assume every message eventually gets delivered.
- Execution produces a sequence of (global) configurations.
- Notice that:
 - In an execution in which all processes start with 0, the only allowed decision is 0.
 - If all processes start with 1, the only allowed decision is 1.
 - For “mixed inputs”, either decision is OK.

[FLP] impossibility proof

- Prove that the algorithm must yield a pattern of four configurations, C_0, C_1, D_0, D_1 , where:
 - D_0 follows from C_0 in one step, in which a particular process p_i receives a particular message m .
 - D_1 follows from C_1 in one step, in which the same process p_i receives the same message m .
 - C_1 follows from C_0 in one step, in which a process p_j receives a message m' .
 - From D_0 , only decision 0 is possible: D_0 is 0-valent.
 - From D_1 , only decision 1 is possible: D_1 is 1-valent.
- Thus, we can “localize” a decision to a particular pattern of configurations.
- For if not, then we could make the algorithm execute forever, with all processes continuing to take steps, and no one ever deciding.
- Contradicts the termination requirement.

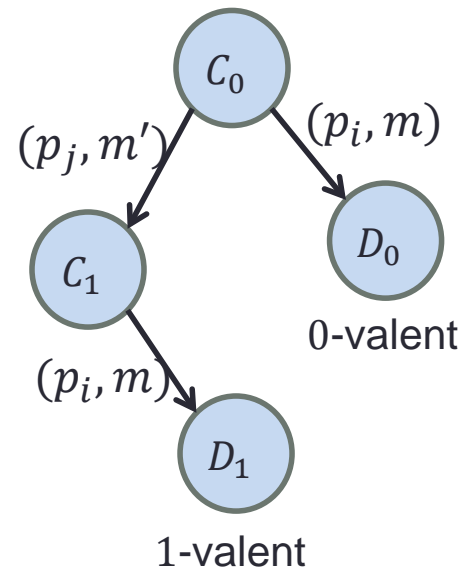

[FLP] impossibility proof

- If such a pattern doesn't exist, we can make the algorithm execute forever, with all processors continuing to take steps, and no one ever deciding, a contradiction.
- **How?**
- Obtain an initial undecided (“bivalent”) configuration.
- Then continue forever, allowing every message (p_i, m) to be delivered, in turn, while keeping the execution undecided.
- E.g., consider a particular (p_i, m) .
- If we can't ever deliver (p_i, m) and remain undecided, then no matter when we deliver it, a decision is determined.
- But both decisions 0 and 1 are possible, after some executions.
- Interchange steps until the two decisions are adjacent, as in the pattern.

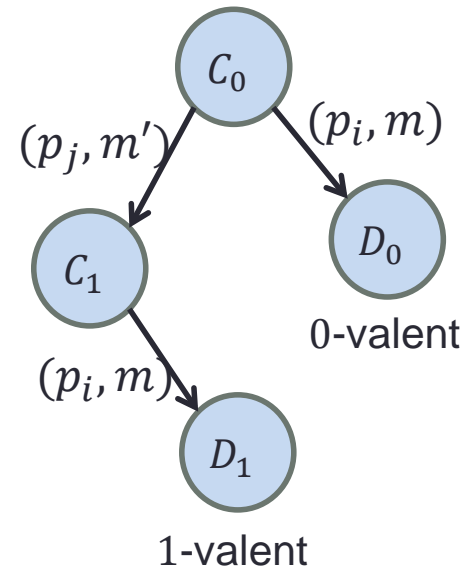

[FLP] impossibility proof

- Now get a contradiction by considering two cases:
- **Case 1: $i \neq j$**
 - Then consider delivering (p_j, m') after D_0 ; still 0-valent.
 - So delivering (p_i, m) then (p_j, m') yields 0-valence, but delivering (p_j, m') then (p_i, m) yields 1-valence.
 - But the two steps occur at different processes, so their relative order can't matter.
 - Contradiction.
- **Case 2: $i = j$**
 - Then consider any deciding execution from C_0 in which p_i fails, takes no steps, but everyone else does.
 - Applying the same execution from D_0 must lead to a decision of 0.
 - Applying the same execution from D_1 must lead to a decision of 1.
 - But the other processes can't distinguish these cases!
 - Contradiction.

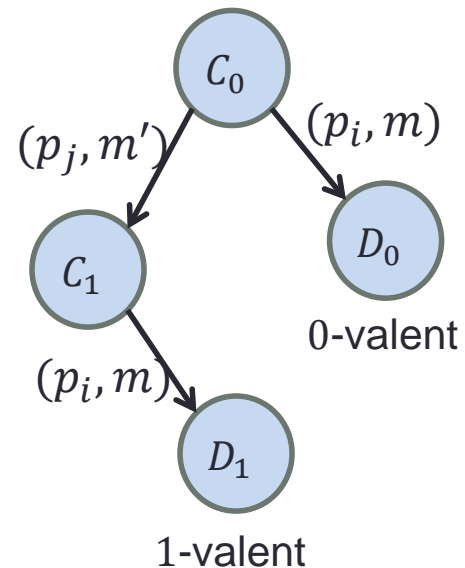

Significance for distributed systems

- Consensus is an important problem in practice, for example, for distributed database commit.
- [FLP] result shows limitations on the kind of algorithm one could hope to find, for agreement problems.
- To get around the impossibility result, one can:
 - Use random choices: [Ben-Or, 83]
 - Rely on timing assumptions: [Dolev, Dwork, Stockmeyer, 87]
 - Weaken requirements carefully: [DLS 88]:
 - Agreement, validity always hold.
 - Termination required if/when system behavior “stabilizes”: no new failures, and timing within “normal” bounds.

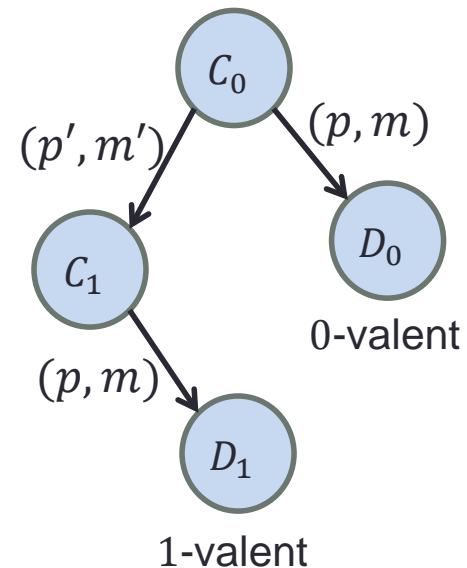

More Impossibility Results: Timing-Dependent Systems

- Lundelius, Lynch. An upper and lower bound for **clock synchronization**. Information and Control, 1984.
- Attiya, Lynch. Time bounds for **real-time process control** in the presence of timing uncertainty. Real-Time Systems Symposium, 1989.
- Lynch, Shavit. Timing-based **mutual exclusion**. RTSS, 1992.
- Attiya, Dwork, Lynch, Stockmeyer. Bounds on the time to reach **agreement** in the presence of timing uncertainty. JACM, 1993.
- Attiya, Lynch, Shavit. Are **wait-free algorithms** fast? JACM, 1994.
- Fan, Lynch. **Gradient clock synchronization**. PODC, 2004; Distributed Computing, 2006.

More Impossibility Results

- Fekete, Lynch, Mansour, Spinelli. The impossibility of implementing reliable communication in the face of crashes. JACM, 1993.
- Afek, Attiya, Fekete, Fischer, Lynch, Mansour, Wang, Zuck. Reliable communication over unreliable channels. JACM, 1994.
- ...
- Lynch. A hundred impossibility proofs for distributed computing. PODC 1989.
- Ellen, Ruppert. Hundreds of impossibility results for distributed computing. Distributed Computing 2003.

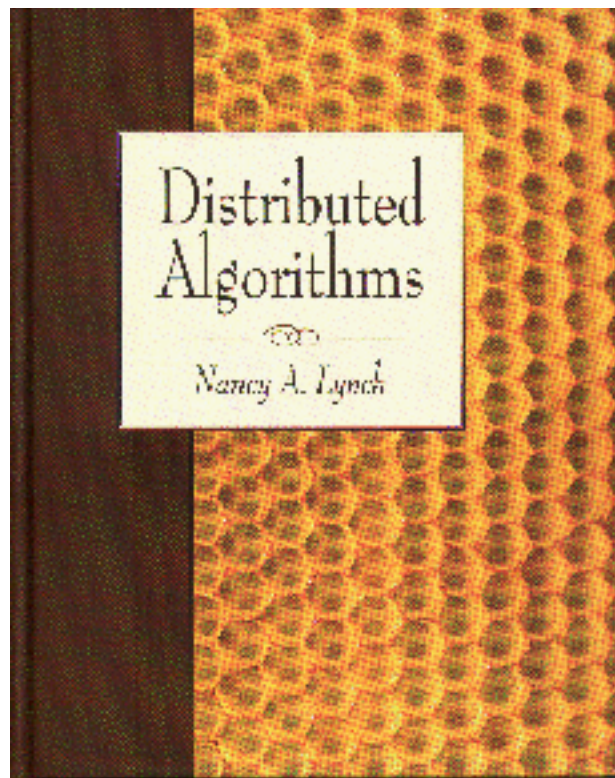

More Impossibility Results: The CAP theorem

- Gilbert, Lynch. Brewer's conjecture and the feasibility of consistent, available, partition-tolerant web services. SIGACT NEWS, 2002.
- Gilbert, Lynch. Perspectives on the CAP Theorem. Computer, 2012.

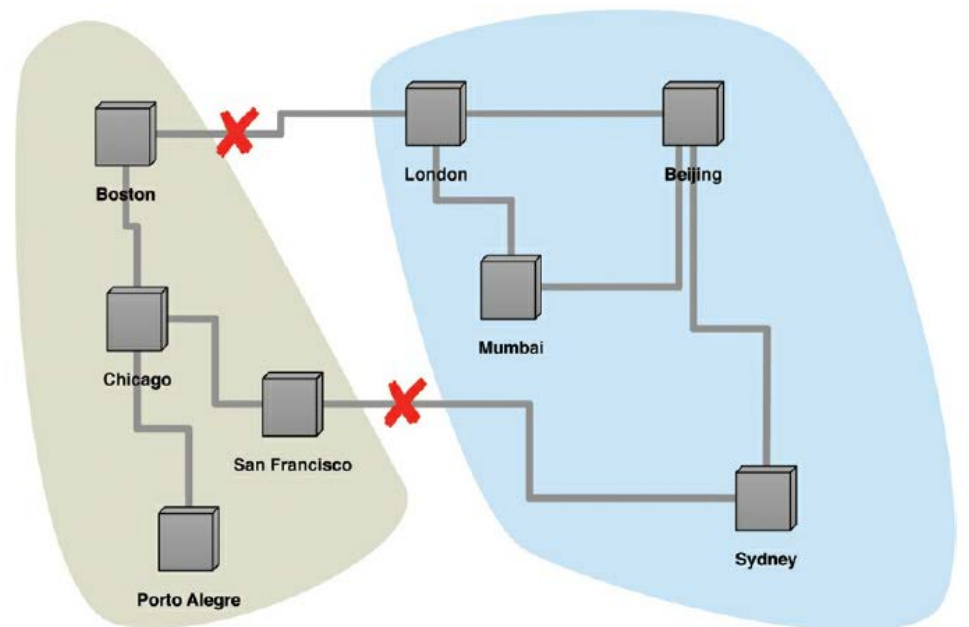

[Gilbert, Lynch]

- Brewer's conjecture and the feasibility of consistent, available, partition-tolerant web services.
- Derived from an informal conjecture described by Brewer in a PODC 2000 keynote.
- Brewer described three desirable properties for Web services:
 - **Consistency:** Data should appear atomic.
 - **Availability:** Every request to perform an operation should eventually return some result.
 - **Partition-tolerance:** Tolerates lost messages.
- **Brewer's informal claim:** In general, can't achieve all three.
- We formalized the properties; identified several different versions, some possible, some impossible.

[Gilbert, Lynch]

- **Consistency:** Atomic Read/Write data objects.
- **Availability:** Read/Write requests should always return.
- **Partition-tolerance:** Any set of messages may be lost.
- We considered:
 - Asynchronous and partially synchronous models.
 - Whether consistency may be violated when messages are lost.
- **Asynchronous case:** Unbounded message delay.
- **Theorem 1:** Impossible to guarantee availability, atomicity in all executions, while allowing any set of lost messages.
- **Proof idea:** Partition the network into two parts, G_1 and G_2 . Suppose a write occurs in G_1 , then a read in G_2 . Read can't know about the write.

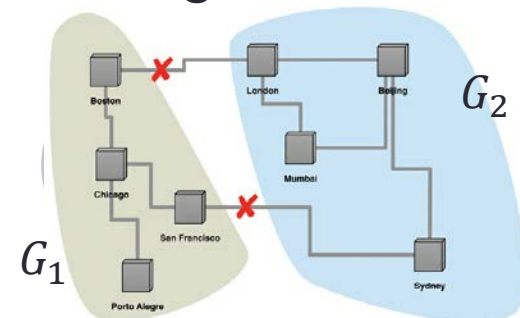

Asynchronous case, cont'd

- **Theorem 1:** Impossible to guarantee availability, atomicity in all executions, while allowing any set of lost messages.
- **Q:** What if we drop the atomicity requirement when partitions occur?
- **Theorem 2:** Impossible to guarantee availability in all executions, atomicity in executions in which no messages are lost, while allowing any set of lost messages in general.
- **Proof idea:** Processors don't know whether messages have been lost, or may arrive later.
- A violation of atomicity occurs at a finite point in time; but then we could extend the execution to deliver all messages.

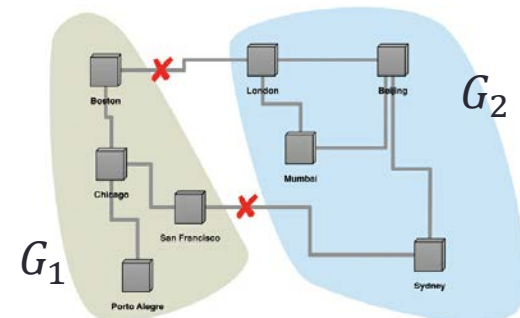

Partially synchronous case

- Local timers; not synchronized, increase at the same rate.
- Can schedule actions to occur at particular local times.
- Messages that aren't lost are delivered within a known time delay.
- **Theorem 3:** (like Theorem 1) Impossible to guarantee availability, atomicity in all executions, while allowing any set of lost messages.
- **Proof:** Similar to Theorem 1.
- But now we get:
- **Theorem 4:** Possible to guarantee availability in all executions, atomicity in executions in which no messages are lost, while allowing any set of lost messages in general.
- **Proof idea:** Now can detect lost messages.
- Strengthen Theorem 4 to give interesting, weaker consistency guarantees even when messages are lost.

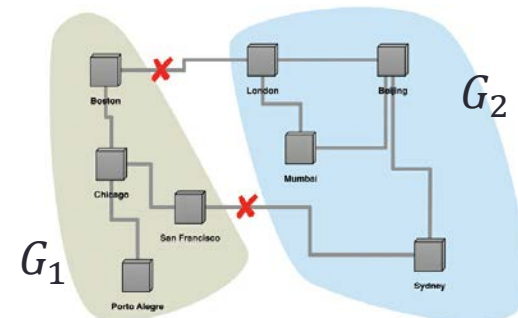

This talk:

1. Algorithms for Traditional Distributed Systems
2. Impossibility Results
3. Foundations
4. Algorithms for New Distributed Systems

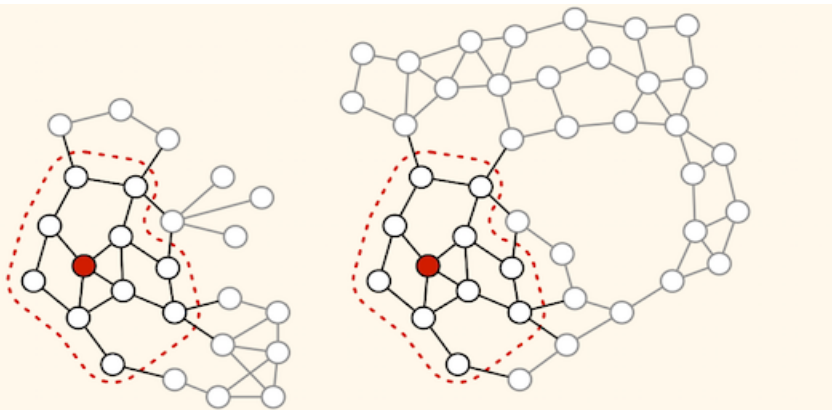

3. Formal Modeling and Verification

- Lynch, Fischer. On describing the behavior and implementation of distributed systems. Theoretical Computer Science, 1981.
- Lynch, Tuttle. An introduction to Input/Output automata. CWI-Quarterly, 1989.
- Lynch, Tuttle. Hierarchical correctness proofs for distributed algorithms. PODC, 1987.
- Lynch, Multivalued possibilities mappings. REX Workshop, 1990.
- Lynch, Vaandrager. Forward and backward simulations. Information and Computation 1995.

I/O Automata

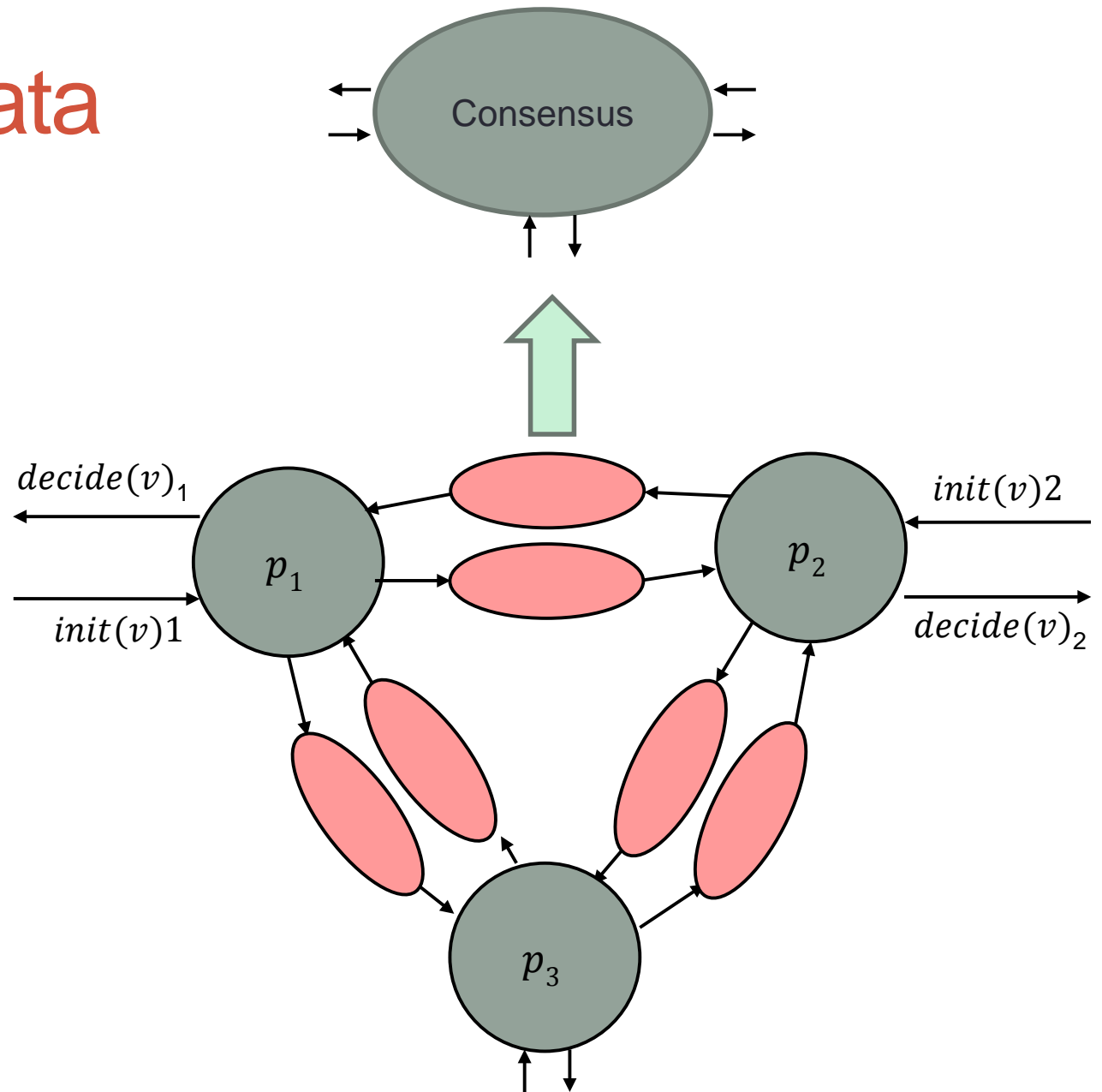

Timed I/O Automata

- Lynch, Vaandrager. Forward and backward simulations II: Timing-based systems. *Information and Computation* 1996.
- Lynch, Segala, Vaandrager. Hybrid I/O automata. *Information and Computation*, 2003.
- Kaynar, Lynch, Segala, Vaandrager. The theory of timed I/O automata. *Synthesis Lectures on Distributed Computing Theory* 2006, 2010.

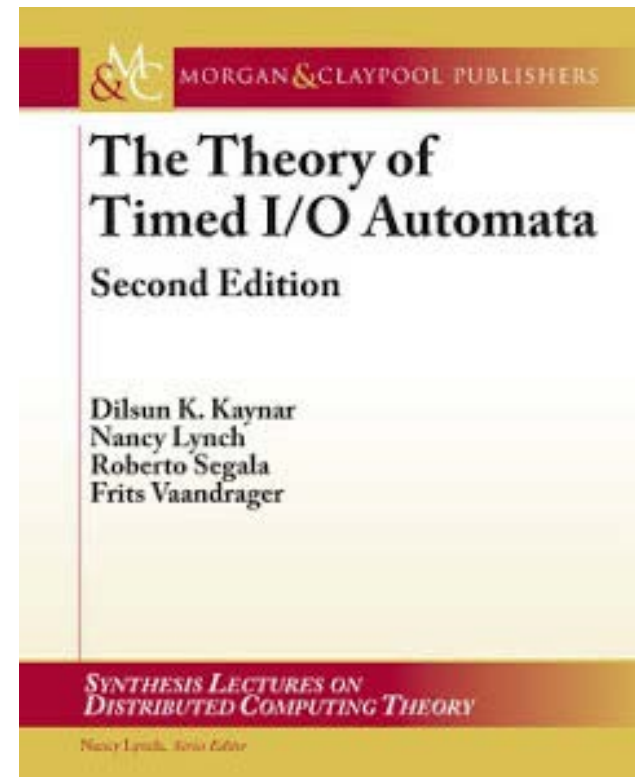

Probabilistic and Dynamic I/O Automata

- Lynch, Segala, Vaandrager. Compositionality for probabilistic automata. CONCUR, 2003.
- Lynch, Segala, Vaandrager. Observing branching structure through probabilistic contexts. SIAM J. Computing, 2007
- Attie, Lynch. Dynamic input/output automata: a formal model for dynamic systems. CONCUR 2001. Information and Computation, 2016.

Case Studies

- Heitmeyer, Lynch. The **Generalized Railroad Crossing**: a case study in formal verification of real-time systems. RTSS, 1994.
- Lygeros, Lynch. **Strings of vehicles**: Modeling and safety conditions. Hybrid Systems: Computation and Control, 1998.
- Dolginova, Lynch. **Safety verification for automated platoon maneuvers**. Intl. Workshop on Hybrid and Real-Time Systems, 1997.
- Livadas, Lygeros, Lynch. High-level modeling and analysis of the **Traffic alert and Collision Avoidance System (TCAS)**. RTSS, 1999.
- Mitra, Wang, Lynch, Feron. Safety verification of **model helicopter controller** using Hybrid Input/Output automata. HSCC, 2003.
- Fan, Droms, Griffeth, Lynch. The **DHCP failover protocol**: A formal perspective. International Conference on Formal Techniques for Networked and Distributed Systems (FORTE), 2007.

Modeling Tools

- Lynch, Michel, Shvartsman. Tempo: A toolkit for the Timed Input/Output Automata formalism. Intl. Conf on Simulation Tools and Techniques for Communications, Networks, and Systems, 2008.
- Lynch, Garland, Kaynar, Michel, Shvartsman. The Tempo language user guide and reference manual. MIT, 2008.
- Georgiou, Lynch, Mavrommatis, Tauber. Automated implementation of complex distributed algorithms specified in the IOA language. ISCA, 2005. Software tools for technology transfer, 2009.



This talk:

1. Algorithms for Traditional Distributed Systems
2. Impossibility Results
3. Foundations
4. Algorithms for New Distributed Systems

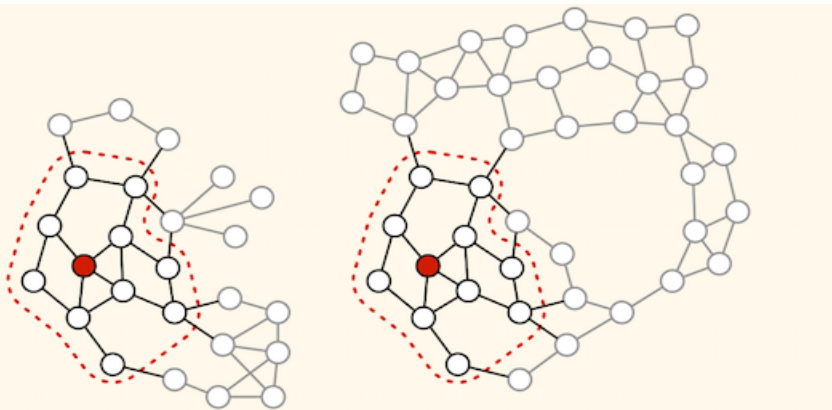

4. Algorithms for New Distributed Systems

- So far, I have described work on algorithms from traditional distributed systems.
- But for the past decade, we have been working on new types of distributed systems: those in which noise, uncertainty, and change predominate:
 - **Wireless networks**
 - **Biological systems**
- Same kinds of research:
 - Abstract models for problems and algorithms.
 - New algorithms.
 - Proofs of correctness, performance,...
 - Impossibility results and lower bounds.
 - General foundations.

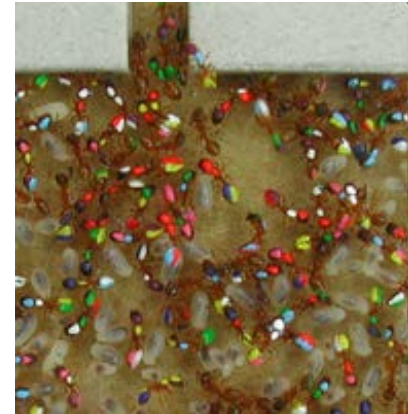

Wireless Networks

- Ad hoc, no central base station, usually mobile.
- Soldiers, first responders, explorers,...
- **Challenge:** Find good abstraction layers to simplify the task of designing applications for ad hoc wireless networks.
- **Idea 1:** Virtual Node layers
- **Idea 2:** Abstract MAC (Reliable Local Broadcast) layers



Idea 1: Virtual Node Layers

- Dolev, Gilbert, Lynch, Shvartsman, Welch. GeoQuorums: Implementing atomic memory in mobile ad hoc networks. DISC 2003.
- Dolev, Gilbert, Lynch, Schiller, Shvartsman, Welch. Virtual Mobile Nodes for mobile ad hoc networks. DISC, 2004.
- Dolev, Gilbert, Lahiani, Lynch, Nolte. Timed Virtual Stationary Automata for mobile networks. OPODIS, 2005.
- Dolev, Lahiani, Lynch, Nolte. Self-stabilizing mobile node location management and message routing. Symp. on Self-Stabilizing Systems (SSS), 2005.
- Lynch, Mitra, Nolte. Motion coordination using Virtual Nodes. CDC, 2005.
- Brown, Gilbert, Lynch, Newport, Nolte, Spindel. The Virtual Node layer: A programming abstraction for wireless sensor networks. SIGBED Review, 2007.
- Gilbert, Lynch, Mitra, Nolte. Self-stabilizing robot formations over unreliable networks. ACM Transactions on Autonomous and Adaptive Systems, 2009.

Virtual Node Layers

- Simplify programming for an ad hoc mobile network by adding **Virtual Nodes (VNs)** at known locations.
- Write algorithms and applications using Virtual Nodes.
- Mobile nodes emulate Virtual Nodes:
 - Each VN is emulated by nodes in its vicinity.
 - Use a full replication or leader-based strategy.
- Applications:
 - Implement atomic memory in a mobile network
 - Geographical message routing
 - Regional motion coordination: robot swarms, Virtual Traffic Lights, Virtual Air-Traffic Controllers,...

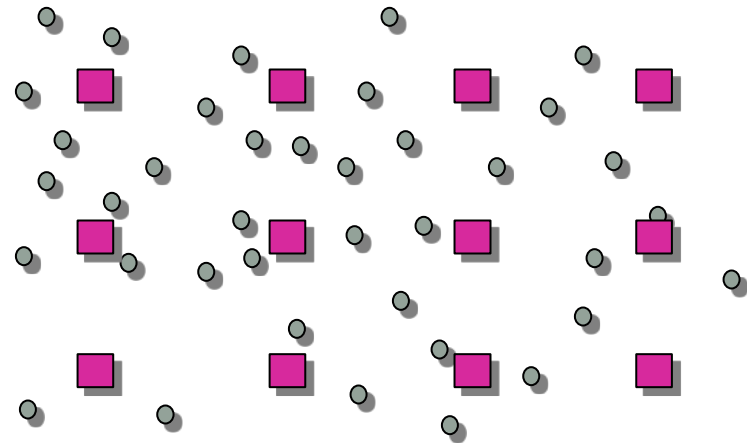

Virtual Traffic Light (VTL)

- For an intersection without a real traffic light.
- Computers in cars emulate a VN, which is programmed to act like a traffic light.
- Any policy desired, e.g., 30 sec in each direction.
- Cars see **red** or **green**, on local displays.
- VTL dies when no cars are around, but that's OK.

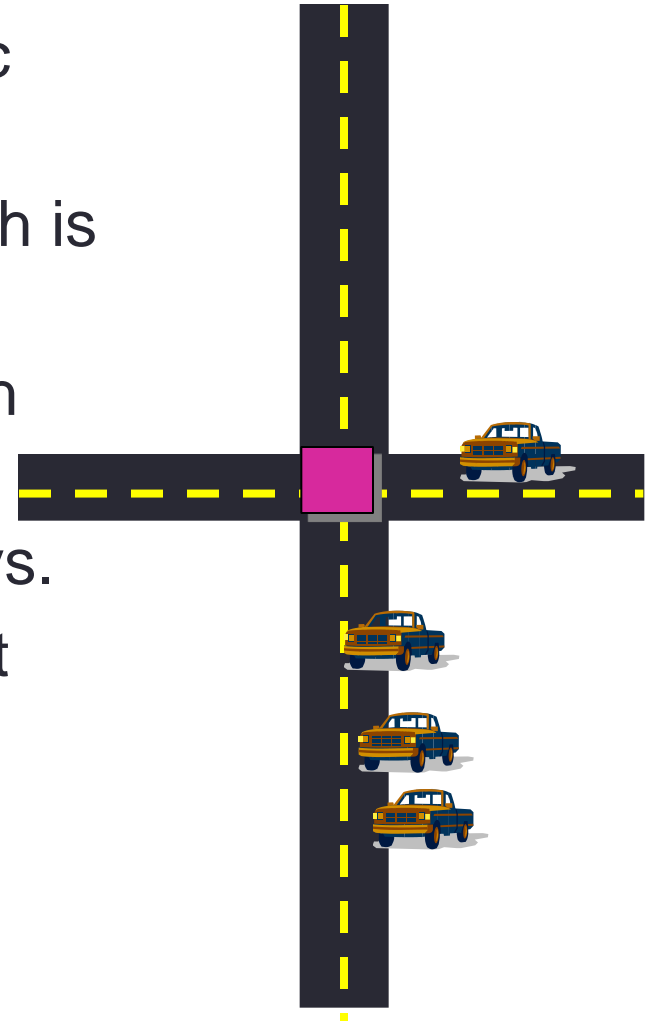

Virtual Air-Traffic Controllers

- Aircraft in regions of airspace without ground-based controllers, e.g., the ocean.
- To control access to regions, use VATCs, emulated by computers on the aircraft.
- VATC behaves like a human ATC:
 - Keeps track of aircraft in local region.
 - Tells neighbor ATCs when to hand off aircraft.
 - Tells aircraft how to move within local region.

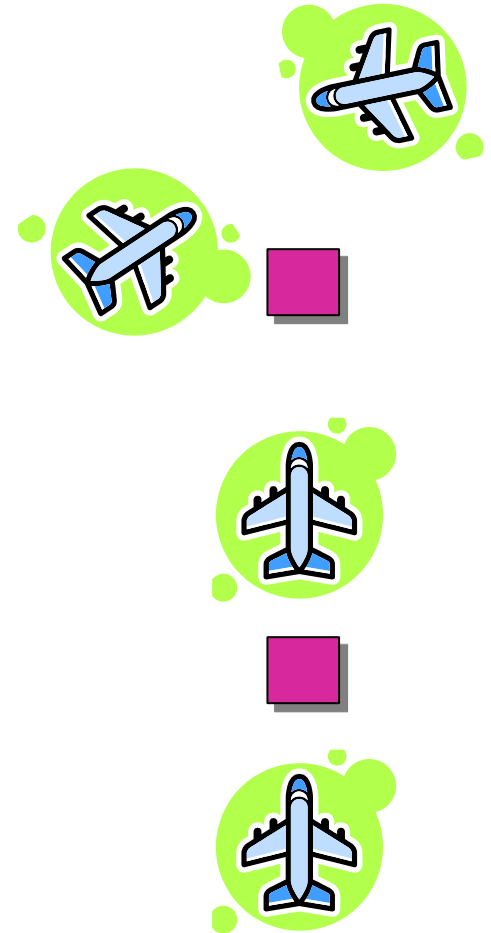

Dealing With Unreliable Communication

- Our Virtual Node work assumed a wireless communication model based on reliable local broadcast.
- But real wireless communication is not so reliable---it's subject to **collisions**, with resulting **message losses**.

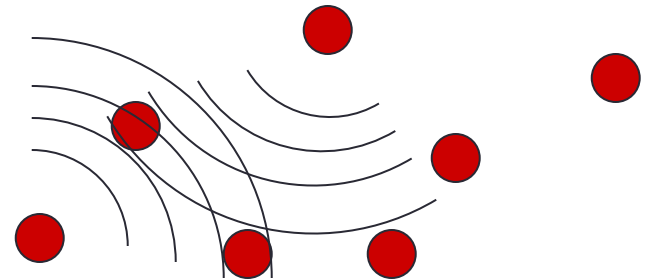

Message Collision Model

- In each round, some nodes transmit, the others listen.
- Transmitter hears only its own message.
- Listener hears:
 - Silence (\perp), if none of its neighbors transmits.
 - A message, if exactly one of its neighbors transmits.
 - Collision (\top), if two or more neighbors transmit.

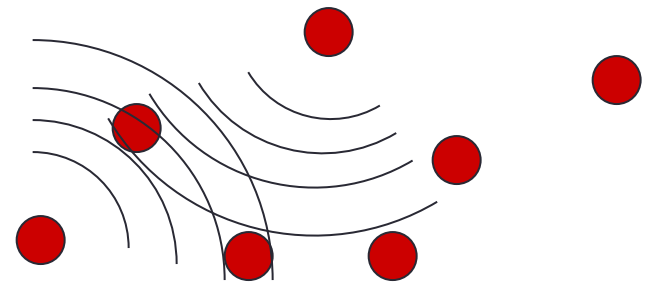

Idea 2: Abstract MAC layers

- Mask collisions within an abstract MAC layer.
- AKA a Reliable Local Broadcast (RLB) layer.
- Implement RLB using low-level collision-management algorithms.
- Build higher-level algorithms over RLB.

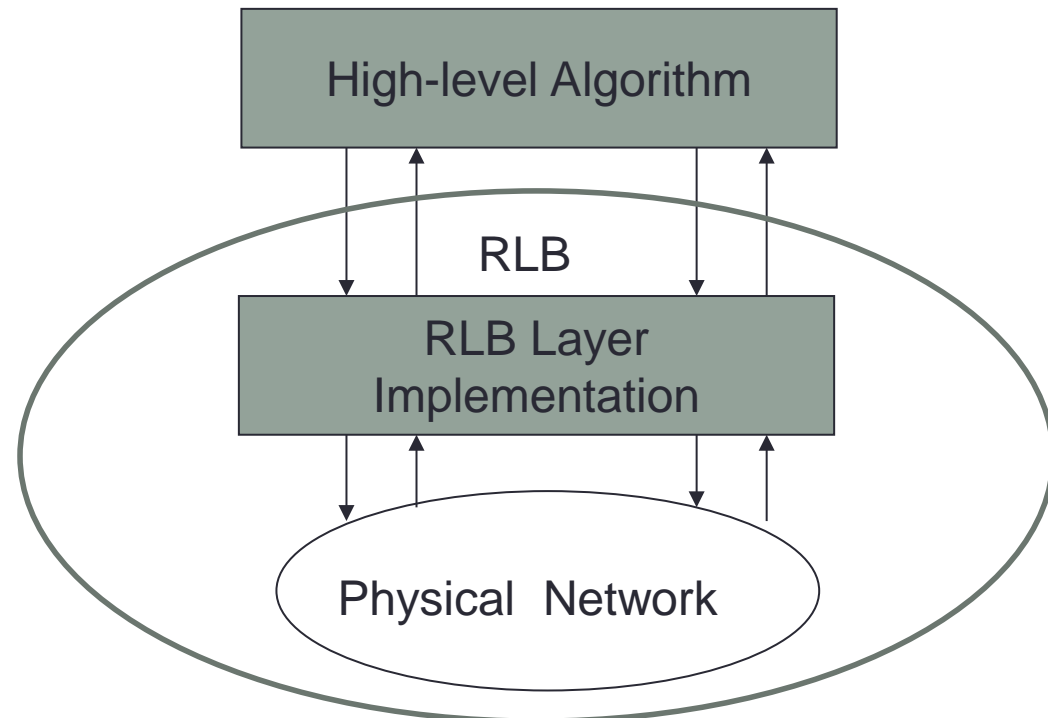

Abstract MAC layers

- Kuhn, Lynch, Newport. The Abstract MAC layer. DISC, 2009. Dist. Comp. 2011.
- Khabbazian, Kowalski, Kuhn, Lynch. Decomposing broadcast algorithms using Abstract MAC layers. Ad Hoc Networks, 2014.
- Halldórsson, Holzer, Lynch. A local broadcast layer for the SINR network model. PODC 2015.

Remarks

- So, we can mask message collisions inside a Reliable Local Broadcast layer.
- Use RLB as an abstraction layer for developing higher-level algorithms.
- **But:** This work considers message collisions, but not communication uncertainty, i.e., uncertainty in where the messages reach.

Communication Uncertainty

- Use two graphs, G and G' :
 - G : Messages **must** reach.
 - G' : Messages **may** reach.

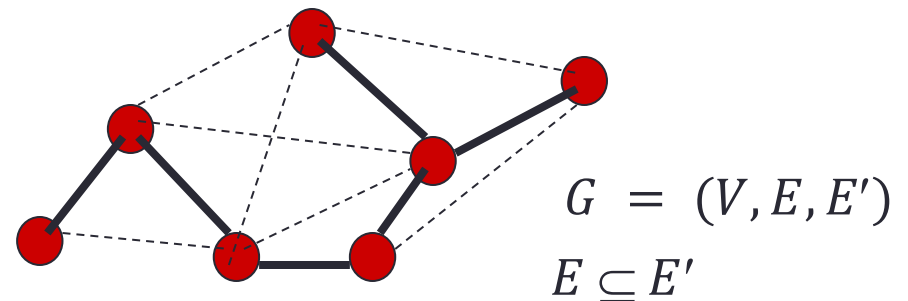
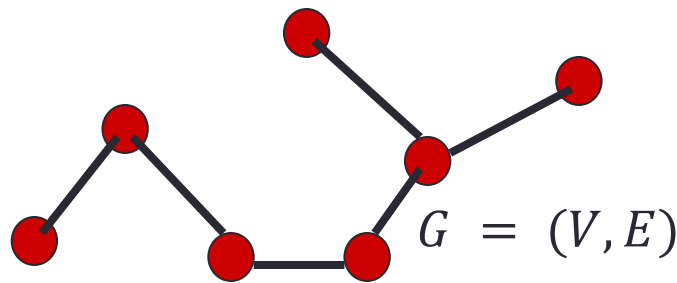

- [Clementi, Monti, Silvestri 04] [Kuhn, Lynch, Newport 09]

Results for the Dual Graph Model

- Kuhn, Lynch, Newport. Hardness of broadcasting in wireless networks with unreliable communication. PODC, 2009.
- Kuhn, Lynch, Newport, Oshman, Richa. Broadcasting in unreliable radio networks. PODC 2010
- Ghaffari, Haeupler, Lynch, Newport. Bounds on contention management in radio networks. DISC, 2012
- Ghaffari, Lynch, Newport. The cost of radio network broadcast for different models of unreliable links. PODC, 2013.
- Censor-Hillel, Gilbert, Kuhn, Lynch, Newport. Structuring unreliable radio networks. DISC, 2014.
- Ghaffari, Kantor, Lynch, Newport. Multi-message broadcast with abstract MAC layers and unreliable links. PODC, 2014.
- Lynch, Newport. A (truly) local broadcast layer for unreliable radio networks. PODC, 2015.
- Gilbert, Lynch, Newport, Pajak. On Simple Back-Off in Unreliable Radio Networks. OPODIS, 2018, Best Paper award.

Biological Systems

- Biological distributed algorithms:
 - Insect colonies
 - Developing organisms
 - Brains
- Simple system models.
- Simple, flexible, robust, adaptive algorithms.
- Two complementary goals:
 - Help to understand biological systems.
 - Suggest new ideas for wireless network algorithms.

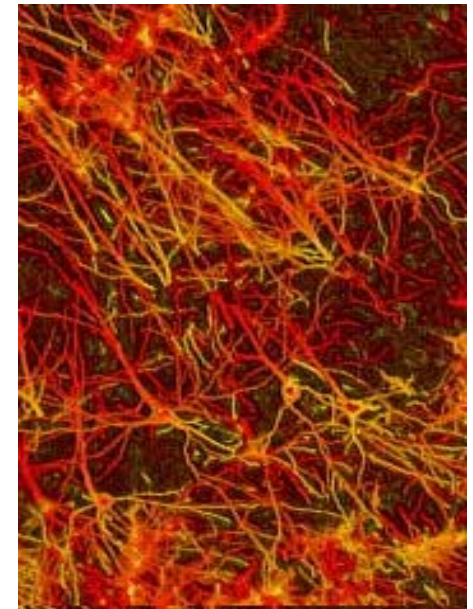
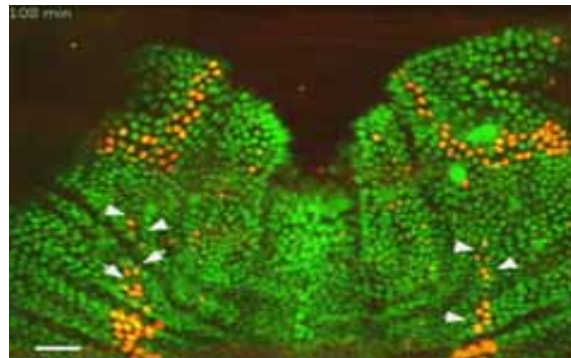
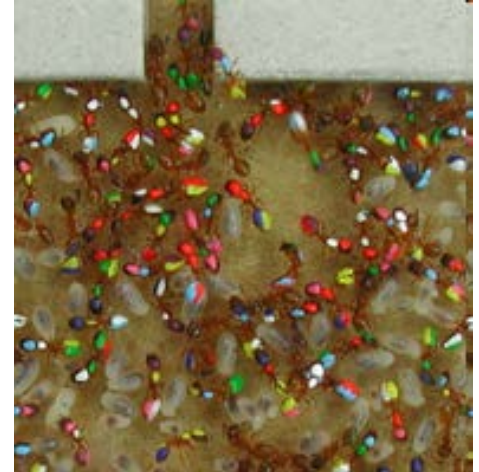

Biological Systems

- Insect colony problems/algorithms:
 - Task allocation in ant colonies
 - Exploring for food (searching)
 - Agreeing on a new nest (consensus)
 - Colony density estimation
- Developing organisms:
 - Scale-independent pattern formation (French Flag)
- Brains:
 - Winner-take-all (leader election)
 - Similarity detection
 - Neural coding
 - Temporal-spatial translation
 - Learning neural representations

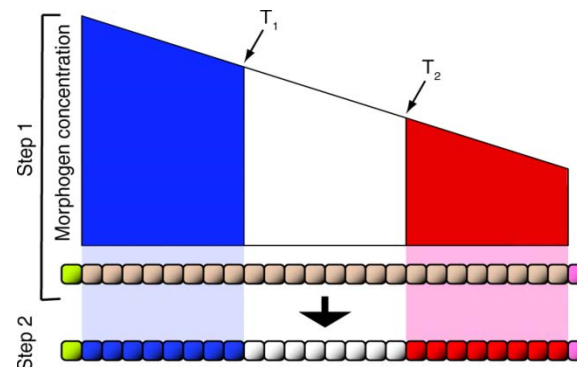
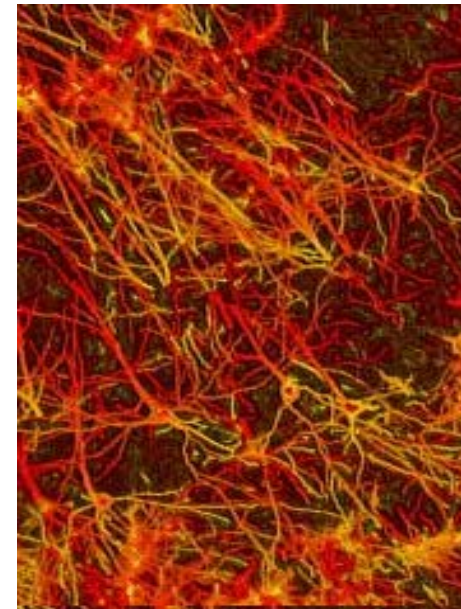
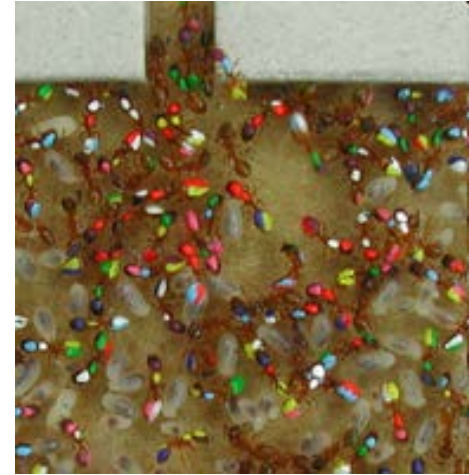

Conclusions

- My collaborators and I have worked on theory of distributed systems, to help understand their capabilities and limitations.
- This work has included:
 - Abstract **models** for systems problems and algorithms.
 - New **algorithms**.
 - Rigorous **proofs** of correctness, performance, ..., discovery of errors.
 - **Impossibility results** and lower bounds, expressing inherent limitations.
 - General **foundations** for modeling, analyzing distributed systems.
- Many kinds of systems:
 - Distributed data-management systems
 - Wired, wireless communication systems
 - Biological systems: Insect colonies, developmental biology, brains.
- **But there is still much more to be done!**

Thanks to my many, many
collaborators!

Thank you!

